

液压缸的附件

符合ISO 6982, ISO 8132和ISO 8133标准

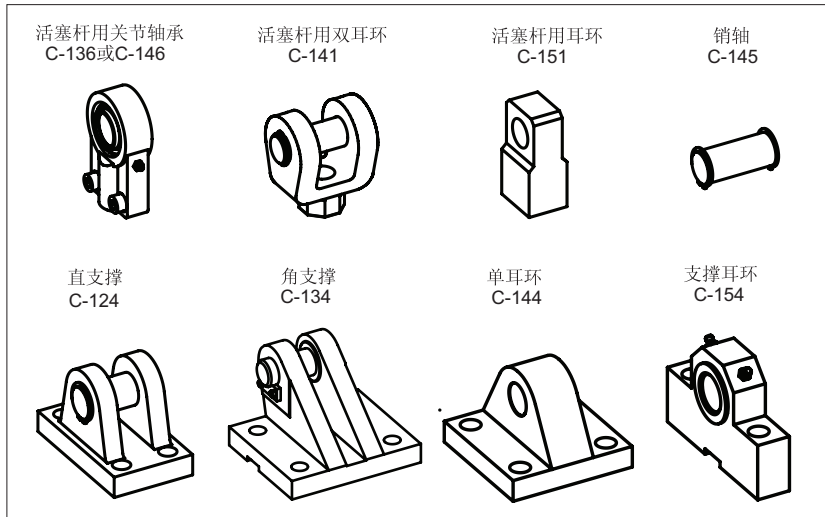

对于每种缸径, Atos可提供标准的活塞杆附件和支撑, 如左图所示。不同的组合请参考第②节。

1 型号代码

C	-	141	12
标准附件			缸径/杆径 (mm)









活塞杆附件

- 136 = 活塞杆用关节轴承
- 146 = 活塞杆用关节轴承
- 141 = 活塞杆用双耳环
- 151 = 活塞杆用单耳环
- 145 = 双耳环用销轴

支撑件

- 124 = 直支撑
- 134 = 角支撑
- 144 = 单耳环
- 154 = 支撑耳轴

2 可能的组合一览表

Ø 杆径	活塞杆附件型号					Ø 缸径	支撑件型号			
										
12 18 选项H*	N0	C-14612	C-14112	C-15112	C-14512	25	N0	C-13425	C-14425	C-15425
14 22 选项H*	C-13614	C-14614	C-14114	C-15114	C-14514	32	C-12432	C-13432	C-14432	C-15432
18 28 选项H*	C-13618	C-14618	C-14118	C-15118	C-14518	40	C-12440	C-13440	C-14440	C-15440
22 36 选项H*	C-13622	C-14622	C-14122	C-15122	C-14522	50	C-12450	C-13450	C-14450	C-15450
28 45 选项H*	C-13628	C-14628	C-14128	C-15128	C-14528	63	C-12463	C-13463	C-14463	C-15463
36 56 选项H*	C-13636	C-14636	C-14136	C-15136	C-14536	80	C-12480	C-13480	C-14480	C-15480
45 70 选项H*	C-13645	C-14645	C-14145	C-15145	C-14545	100	C-124100	C-134100	C-144100	C-154100
56 90 选项H*	C-13656	C-14656	C-14156	C-15156	C-14556	125	C-124125	C-134125	C-144125	C-154125
70 110 选项H*	C-13670	C-14670	C-14170	C-15170	C-14570	160	C-124160	C-134160	C-144160	C-154160
90 140 选项H*	C-13690	C-14690	C-14190	C-15190	C-14590	200	C-124200	C-134200	C-144200	N0

备注:

(*)选项H: 轻型外螺纹, 详细信息参考样本B137或B140。

(**)对于活塞杆110,140,180和220, 同样可提供C-136。参见第③节。

3 尺寸[mm]

C-136-活塞杆用关节轴承
符合ISO6982和8132标准

备注:
(1) 附件带有自润滑, 因此不配置润滑器。
(2) 当油缸在工作中受到高频率的振荡和推拉时, 应考虑动载荷。

代码	KK	AX min	B max	C max	CB max	CH js13	CN H7	EN h7	H	LF min	NC	质量 [kg]	最大负载 [kN] (2)	静态
C-13616 (1)	M12x1,25	17	16	32	11	38	12	12	54	17	32	0,11	10,8	24,5
C-13618	M14x1,5	19	21	40	13	44	16	16	64	19	40	0,20	17,6	36,5
C-13622	M16x1,5	23	25	47	17	52	20	20	75	23	47	0,35	30	48
C-13628	M20x1,5	29	30	58	22	65	25	25	96	29	54	0,62	48	78
C-13636	M27x2	37	38	71	28	80	32	32	118	37	66	1,15	67	114
C-13645	M33x2	46	47	90	33	97	40	40	146	46	80	2,18	100	204
C-13656	M42x2	57	58	109	41	120	50	50	179	57	96	3,96	156	310
C-13670	M48x2	64	70	136	53	140	63	63	211	64	114	6,80	255	430
C-13690	M64x3	86	90	170	67	180	80	80	270	86	148	13,00	400	695
C-13690A	M72x3	91	100	185	72	195	90	90	296	91	160	19,10	490	750
C-136110	M80x3	96	110	211	85	210	100	100	322	96	178	25,00	610	1,060
C-136110A	M90x3	106	125	235	88	235	110	110	364	106	190	32,00	655	1,200
C-136140	M100x3	113	135	265	103	260	125	125	405	113	200	46,00	950	1,430
C-136180	M125x4	126	165	326	130	310	160	160	488	126	250	82,50	1,370	2,200
C-136220	M160x4	161	215	418	162	390	200	200	620	161	320	168,00	2,120	3,650

C-146-活塞杆用关节轴承
符合ISO8133标准

备注:
(1) 附件带有自润滑, 因此不配置润滑器。
(2) 当油缸在工作中受到高频率的振荡和推拉时, 应考虑动载荷。

代码	KK	AX min	CH js13	CX	EF max	EN	EU max	LF min	N max	质量 [kg]	最大负载 [kN] (2)	静态
C-14612(1)	M10x1,25	15	42	12 ⁰ _{-0,008}	20	10 ⁰ _{-0,12}	8	16	17	0,12	10,8	17
C-14614(1)	M12x1,25	17	48	16 ⁰ _{-0,008}	22,5	14 ⁰ _{-0,12}	11	20	21	0,22	21,1	28,5
C-14618(1)	M14x1,5	19	58	20 ⁰ _{-0,01}	27,5	16 ⁰ _{-0,12}	13	28	25	0,43	30	42,5
C-14622	M16x1,5	23	68	25 ⁰ _{-0,01}	32,5	20 ⁰ _{-0,12}	17	31	30	0,67	48	67
C-14628	M20x1,5	29	85	30 ⁰ _{-0,01}	40	22 ⁰ _{-0,12}	19	35	36	1,25	62	108
C-14636	M27x2	37	105	40 ⁰ _{-0,012}	50	28 ⁰ _{-0,12}	23	45	45	2,16	100	156
C-14645	M33x2	46	130	50 ⁰ _{-0,012}	60	35 ⁰ _{-0,12}	30	58	55	3,90	156	245
C-14656	M42x2	57	150	60 ⁰ _{-0,015}	80	44 ⁰ _{-0,15}	38	68	68	7,15	245	380
C-14670	M48x2	64	185	80 ⁰ _{-0,015}	102,5	55 ⁰ _{-0,15}	47	82	90	15,00	400	585
C-14690	M64x3	86	240	100 ⁰ _{-0,02}	120	70 ⁰ _{-0,20}	55	116	110	27,30	610	865

C-141-活塞杆用双耳环
符合ISO8133标准

C-145 - 销轴

备注:
销轴C-145*一起提供

代码	KK	CE JS13	CK H9	CL h13	CM A16	EK f8	EL max	ER max	LE min	质量 [kg]	最大负载 静态[kN]
C-14112 C-14512	M10x1,25	32	10	24	12	10	29	12	13	0,10	8
C-14114 C-14514	M12x1,25	36	12	32	16	12	37	17	19	0,18	12,5
C-14118 C-14518	M14x1,5	38	14	40	20	14	45	17	19	0,23	20
C-14122 C-14522	M16x1,5	54	20	60	30	20	66	29	32	0,90	32
C-14128 C-14528	M20x1,5	60	20	60	30	20	66	29	32	0,91	50
C-14136 C-14536	M27x2	75	28	80	40	28	87	34	39	1,92	80
C-14145 C-14545	M33x2	99	36	100	50	36	107	50	54	4,92	125
C-14156 C-14556	M42x2	113	45	120	60	45	129	53	57	6,53	200
C-14170 C-14570	M48x2	126	56	140	70	56	149	59	63	10,11	320
C-14190 C-14590	M64x3	168	70	160	80	70	169	78	83	19,20	500

C-151-活塞杆用耳环
符合ISO8133标准

代码	KK	AW min	B	CA JS13	CB max	CK H9	EM h13	ER max	LE min	质量 [kg]	最大负载 静态[kN]
C-15112	M10x1,25	14	18	32	18	10	12	12	13	0,08	8
C-15114	M12x1,25	16	22	36	22	12	16	17	19	0,15	12,5
C-15118	M14x1,5	18	25	38	20	14	20	17	19	0,22	20
C-15122	M16x1,5	22	35	54	30	20	30	29	32	0,50	32
C-15128	M20x1,5	28	40	60	30	20	30	29	32	1,10	50
C-15136	M27x2	36	50	75	40	28	40	34	39	1,50	80
C-15145	M33x2	45	70	99	50	36	50	50	54	2,50	125
C-15156	M42x2	56	100	113	65	45	60	53	57	4,20	200
C-15170	M48x2	63	116	126	90	56	70	59	63	11,80	320
C-15190	M64x3	85	160	168	110	70	80	78	83	17,00	500

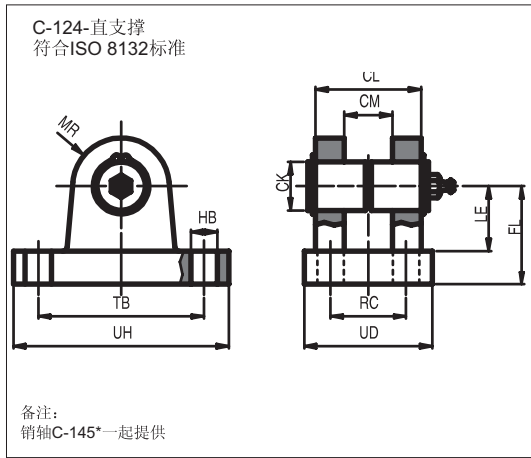

代码	CK H9	CL h16	CM A12	FL JS12	HB H13	LE min	MR max	RC JS14	TB JS14	UD max	UH max	质量 [kg]	最大负载 静态[kN]
C-12414	12	28	12	34	9	22	12	20	50	40	70	0,31	8
C-12418	16	36	16	40	11	27	16	26	65	50	90	0,59	12,5
C-12422	20	45	20	45	11	30	20	32	75	58	98	0,9	20
C-12428	25	56	25	55	13,5	37	25	40	85	70	113	1,6	32
C-12436	32	70	32	65	17,5	43	32	50	110	85	143	2,8	50
C-12445	40	90	40	76	22	52	40	65	130	108	170	5,0	80
C-12456	50	110	50	95	26	65	50	80	170	130	220	10,1	125
C-12470	63	140	63	112	33	75	63	100	210	160	270	15,4	200
C-12490	80	170	80	140	39	95	80	125	250	210	320	30,0	320
C-12490A	90	190	90	160	45	108	90	140	290	230	370	35,0	400

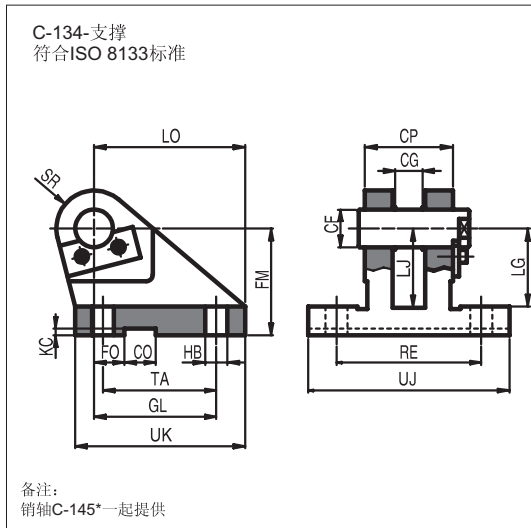

代码	CF K7	CG q11/k8	CO H9	CP h14	FM js11	FO JS13	GL H16	HB H16	KC	LG	LJ min	LO max	RE js13	SR max	TA js13	UJ max	UK	质量 [kg]	最大负载 静态[kN]
C-13425	12	10	10	30	40	16	46	9	3,3	28	29	56	55	12	40	75	60	0,52	8
C-13432	16	14	16	40	50	18	61	11	4,3	37	38	74	70	16	55	95	80	1,05	12,5
C-13440	20	16	16	50	55	20	64	13,5	4,3	39	40	80	85	20	58	120	90	1,72	20
C-13450	25	20	25	60	65	22	78	15,5	5,4	48	49	98	100	25	70	140	110	2,72	32
C-13463	30	22	25	70	85	24	97	17,5	5,4	62	63	120	115	30	90	160	135	5,15	50
C-13480	40	28	36	80	100	24	123	22	8,4	72	73	148	135	40	120	190	170	9,3	80
C-134100	50	35	36	100	125	35	155	30	8,4	90	92	190	170	50	145	240	215	18,3	125
C-134125	60	44	50	120	150	35	187	39	11,4	108	110	225	200	60	185	270	260	35	200
C-134160	80	55	50	160	190	35	255	45	11,4	140	142	295	240	80	260	320	340	63	320
C-134200	100	70	63	200	210	35	285	48	12,4	150	152	335	300	100	300	400	400	109	500

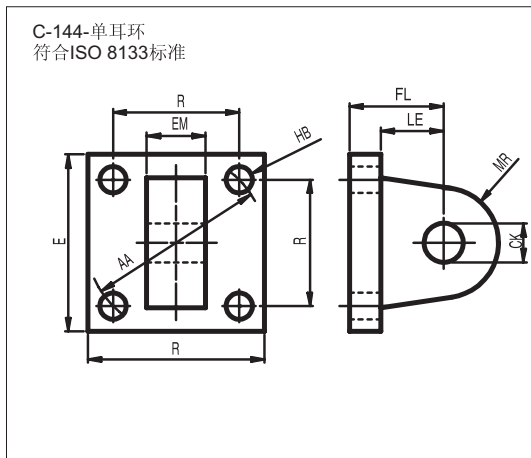

代码	CK H8	AA	E max	EM h13	FL js14	HB H13	LE min	MR max	R js14	质量 [kg]	最大负载 静态[kN]
C-14425	10	40	40	12	23	5,5	13	12	28,3	0,30	8
C-14432	12	47	45	16	29	6,6	19	17	33,2	0,45	12
C-14440	14	59	63	20	29	9	19	17	41,7	0,90	20
C-14450	20	74	75	30	48	13,5	32	29	52,3	1,30	32
C-14463	20	91	90	30	48	13,5	32	29	64,3	1,90	50
C-14480	28	117	115	40	58	17,5	39	34	82,7	4,00	80
C-144100	36	137	130	50	79	17,5	54	50	96,9	6,25	125
C-144125	45	178	165	60	87	24	57	53	125,9	11,40	200
C-144160	56	219	205	70	103	30	63	59	154,9	20,80	320
C-144200	70	269	245	80	132	33	82	78	190,2	38,80	500

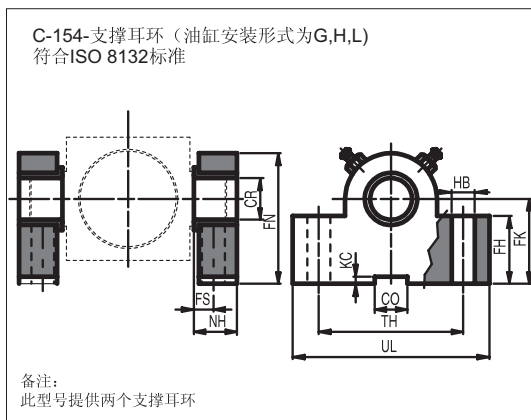

代码	CR H7	CO N9	FH max	FK JS12	FN max	FS H16	HB H13	KC 0/+0,3	NH max	TH js14	UL max	质量 [kg]	最大负载 静态[kN]
C-15425	12	10	25	34	49	8	9	3,3	17	40	63	0,46	8
C-15432	16	16	30	40	59	10	11	4,3	21	50	80	0,83	12,5
C-15440	20	16	38	45	69	10	11	4,3	21	60	90	1,21	20
C-15450	25	25	45	55	80	12	13,5	5,4	26	80	110	2,15	32
C-15463	32	25	52	65	100	15	17,5	5,4	33	110	150	4,63	50
C-15480	40	36	60	76	120	16	22	8,4	41	125	170	7,78	80
C-154100	50	36	75	95	140	20	26	8,4	51	160	210	14,3	125
C-154125	63	50	85	112	177	25	33	11,4	61	200	265	23,4	200
C-154160	80	50	112	140	220	31	39	11,4	81	250	325	53,1	320
C-154200	90	63	145	160	250	40	45	12,4	91	265	345	58,3	385

4 附件举例

CK-安装形式C, 带附件C-144和C-136

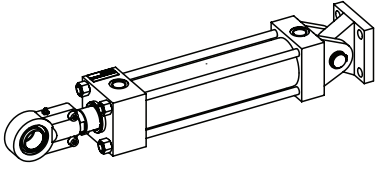

CK-安装形式L, 带附件C-141和C-154

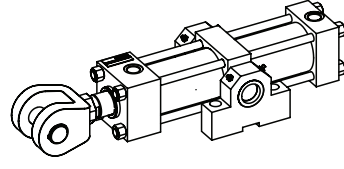

CH-安装形式S, 带附件C-136和C-134

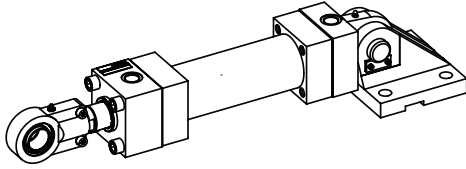

CH-安装形式P, 带附件C-141

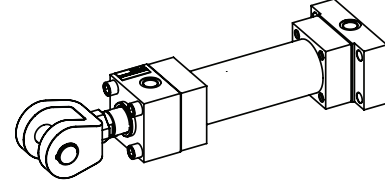

CN-安装形式S, 带附件C-124和C-136

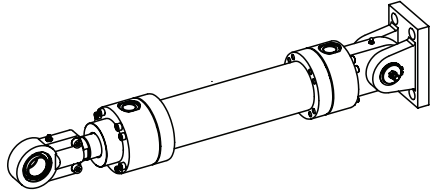

CN-安装形式E, 带附件C-146

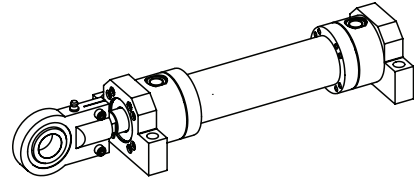

CC-安装形式L, 带附件C-146和C-154

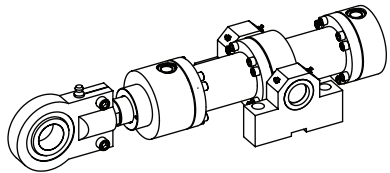

CC-安装形式A, 带附件C-141

